

Sealed Rechargeable Ni-Cd Cell

AA-600

Type: AA-600 (FLAT TOP)

Specifications of single cell (For Reference)

Nominal voltage		1.2V	
Nominal Capacity (C/5 Rate)		600mAh	
Capacity (Time)	At 0.2C Discharge		
	Minimum	270 min	
	Typical	300 min	
Charging Voltage		1.6V	
Discharge Cut off Voltage		1V	
Dimensions	Diameter	14 ± 0.5 mm	
	Height	48.5 ± 0.5 mm	
Weight (Approximately)		grams	
		17	
Internal Impedance At 1000 Hz		30mΩ (Max) (After Charge)	
Charge	Standard	60mA (0.1C) × 16hrs	
	Rapid	180mA (0.3C) × 4hrs	
Ambient Temperature	Charge	Standard	0°C to 40°C
		Rapid	0°C to 40°C
	Discharge		-20°C to 60°C
	Storage		-20°C to 40°C

Dimensions (with tube): in (mm)

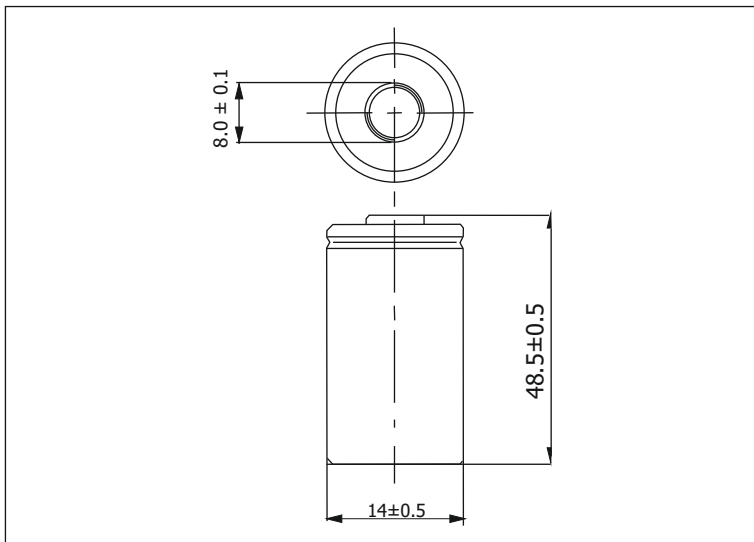

Note :

1. Recharge battery at least once in month.
2. When connecting a battery pack to a charger, ensure correct polarity.
3. Store batteries in a cool dry place.
4. Do not dispose battery in trash, recycle them.

Charge

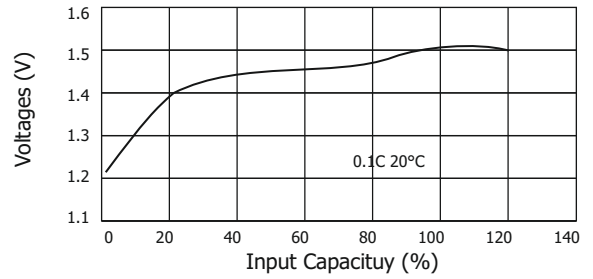

Discharge at high rate (0.5C)

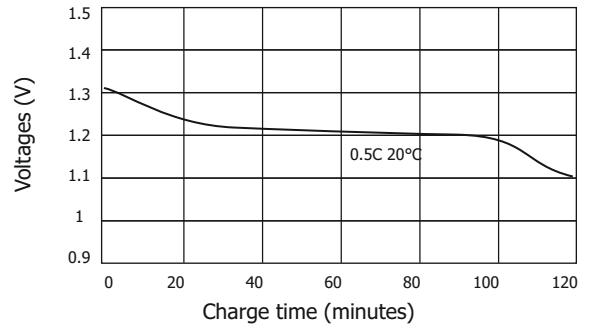

Discharge at low rate

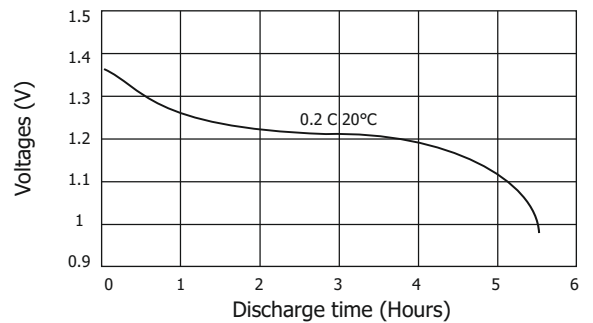

Cycle life characteristics

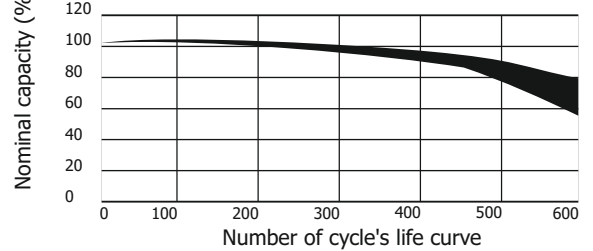

Charge Retention

